

# Implementation of Cloud Controlled Defense Rover using MQTT Protocol

<sup>1</sup>P Srikanth Ranjan, <sup>2</sup>Abhilash K, <sup>3</sup>Amarnath CR, <sup>4</sup>Nikhil VS and <sup>5</sup>Ravikumar KP  
<sup>1,2,3,4</sup>Dept of Electronics and Communication, JSSATE, Bangalore  
cramarnath95@gmail.com

<sup>5</sup>Assistant Professor, Department of Electronics and Communication, JSSATE, Bangalore  
kprk73@gmail.com

**Abstract**—Modern day systems demand mobility and wireless to end users. However most of the systems used in defense up to date still work on wired range or limited wireless transmission. With the advent of satellites, availability of Wi-Fi in almost all places, cloud technology can be used to control and coordinate multiple systems. The following paper proposes control of such embedded systems through cloud using MQTT protocol.

**Index Terms**— MQTT, Cloud, Publish, Subscribe, Defense.

## I. INTRODUCTION

In the past decade robotics has evolved into a massive subject and robotics is being used in almost all applications. Robots are slowly being brought into defense and military applications to do various checks before human intervention and thus help in saving lives.

Prof. Vaibhav Joshi [1] and group have proposed a wireless bomb disposal rover that can be used to dispose of bombs in a region.

Mr. Arun.R and team [2] have proposed another defense rover equipped with gas sensors and PIR sensors to detect harmful gases and bombs.

However one common trait that can be observed in these rovers is that all of them have a limited range of operation of around 500 to 750 m. In modern day warfare such a range would be very less to use. This paper proposes a defense rover that can be controlled through cloud thus making the range virtually limitless.

Cloud Computing, often referred to as cloud is an internet based way to provide processing resources, storage resources, networks, servers to systems which are connected to it with minimal management efforts. Cloud is an omnipresent, provided on demand collection of configurable resources. Cloud computing and storage gives users the ability to store, manage data in a third party server and do the computational processing of the same using the third party resources thus reducing the time and resource required at the user end to perform the same. For instance say an Optical character recognition system requires around 128MB of RAM to operate. The system which uses the OCR will have to allocate these resources to it. Instead if the image is directly sent to a cloud server, it can be processed and output data can be sent back to the original device thus reducing computational resources required at the user end.

The biggest advantage of cloud is that it provides virtually limitless computing resources which can be used by many users based on their requirement. Dynamic allocation of these resources ensures each and every user

doesn't have to compromise on speed of the system during peak hours. Thus cloud eliminates the limit on the number of objects the user can process at a given time.

Another massive advantage while using cloud is the reduction in hardware at the user site. Since most of the hardware resources required are provided by the cloud, the user requires only a way to communicate to the cloud to send and retrieve data thus exponentially decreasing the cost required for the same.

Multiple companies provide Cloud services based on the user requirements. They can be broadly classified as public or private. Public cloud service is basically a 'pay per use' type service available for general public. Private cloud service includes internal data storage and management to business organizations which is not accessible to general public.

Various communication techniques are available to communicate with cloud including HTTP, CoAP, XMPP, and MQTT. This paper focuses on MQTT because of its comparative simplicity and ease of use.

## II. MQTT PROTOCOL

MQTT (Message Queue Telemetry Transport) is light weight, publish-subscribe model based messaging protocol used on top of TCP/IP protocol. It is described to be 'useful for connections with remote locations where a small code footprint is required and/or network bandwidth is at a premium'

Although MQTT was closely associated with IBM, it is now overseen by OASIS (Organization for the Advancement of Structured Information Standards). The latest version v3.1.1

On comparison with HTTP, MQTT provides 93x faster throughput, 8x less network overhead. It also requires only half the power to keep connection open.

## III. WORKING OF MQTT

As discussed above MQTT uses a publish-subscribe model. In MQTT protocol, a device sends information about a given topic to a server/MQTT broker. This broker is then publishes the data to other clients/users who have subscribed to the same topic.

For example in fig1, the sensing device publishes the sensor readings to the server on a prescribed topic say 'READER'. Now all other users who have subscribed to this topic i.e. 'READER' receive the sensor reading and use them. It can also be noted that the broker can process the sensor readings and publish the processed data thus reducing computational overhead to the user

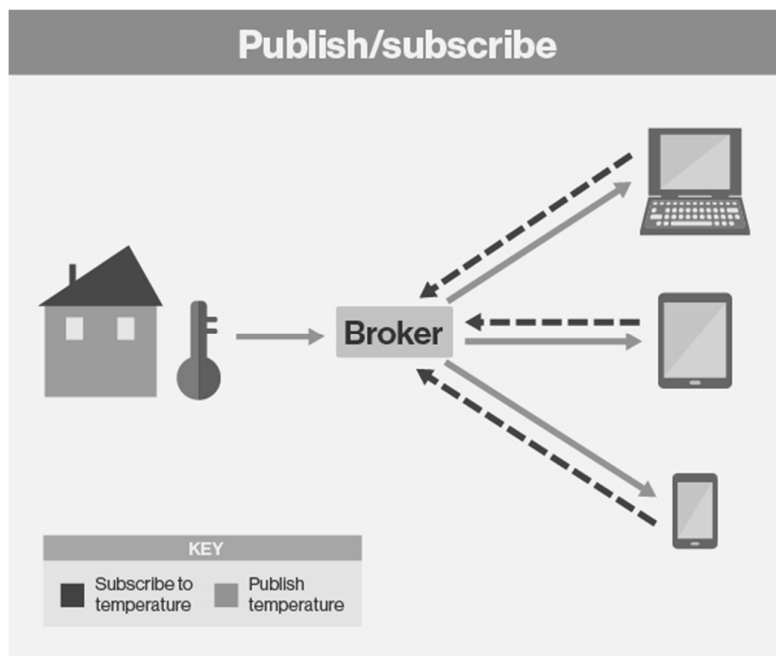

Figure 1. Publish/Subscribe model

#### IV. PROPOSED SYSTEM

The system used in this paper proposes the use of MQTT protocol along with a cloud service provider to improve range of operation and incorporate machine learning.

The defense rover proposed here has a Gas sensor, Metal sensor, Ultrasonic sensor. All these sensors are interfaced to a CC3200 Simple Link™ Wi-Fi® and Internet-of-Things Solution, a Single-Chip Wireless MCU. The board comes with an inbuilt Wi-Fi module thus enabling it to be controlled via cloud.

Though there are number of cloud service providers, we have used IBM Bluemix Cloud IoT platform considering its advantages. Any other cloud platform which has agility and allows the use of Web Applications for the use of real-time data visualization can be used instead.

##### A. TI CC3200:

Shown in Figure 3, TI CC3200 is a wireless MCU that integrates a high-performance ARM Cortex M4, thus allowing users to develop an entire system with a single Incites Wi-Fi enabled thus eliminating the need of any other hardware for communication

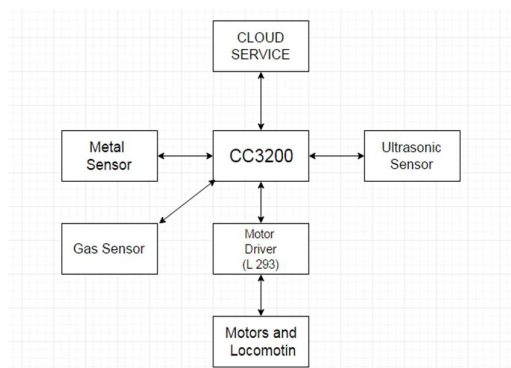

Figure 2. Block Diagram

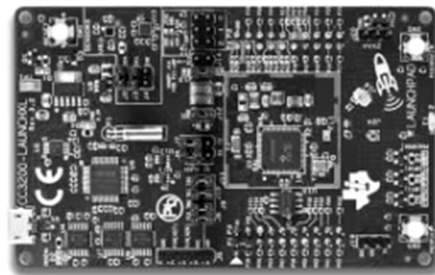

Figure 3. TI CC3200

##### B. Metal Sensor:

Since most of the bombs have metal content in them, the rover is equipped with a metal sensor to detect them. A simple metal sensor is used for the prototype which returns the percentage content of the metal. A typical Metal sensor is shown in Figure 4.



Figure 4. Metal Sensor Figure

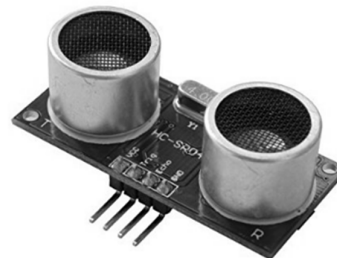

5. Ultrasonic Sensor

##### C. Gas sensors:

Modern warfare includes use of biological weapons and poisonous gases. The Gas sensor would be able to sniff out harmful gases and decide the safety of the environment.

4. Ultrasonic Sensors: Ultrasonic sensors are basically used for object detection. It works on reflection of waves. The time between the incidence and reception of the wave is directly proportional to distance. A regulation Ultrasonic sensor is shown in the figure below. A typical ultrasonic sensor is shown in Figure 5.

## V. TECHNIQUE

The technique used here is quite simple. Two topics are created one for detecting sensor readings and the other for controlling the locomotion of the rover. The rover is made to publish sensor readings into the sensor topic and subscribes to the locomotion topic as shown in figure 6.

The broker is configured such that the command received from the user is communicated to the rover in suitable format. The sensor readings received from the rover is processed and continuously monitored and the user is made aware if there are any discrepancies. The user subscribes to the sensor topic and publishes to the locomotion topic. The user is presented with a user interface as shown in figure 7.

At the rover end, the sensor readings are merged into a single packet. This is later split in the broker and then forwarded to the user as shown figure 8.

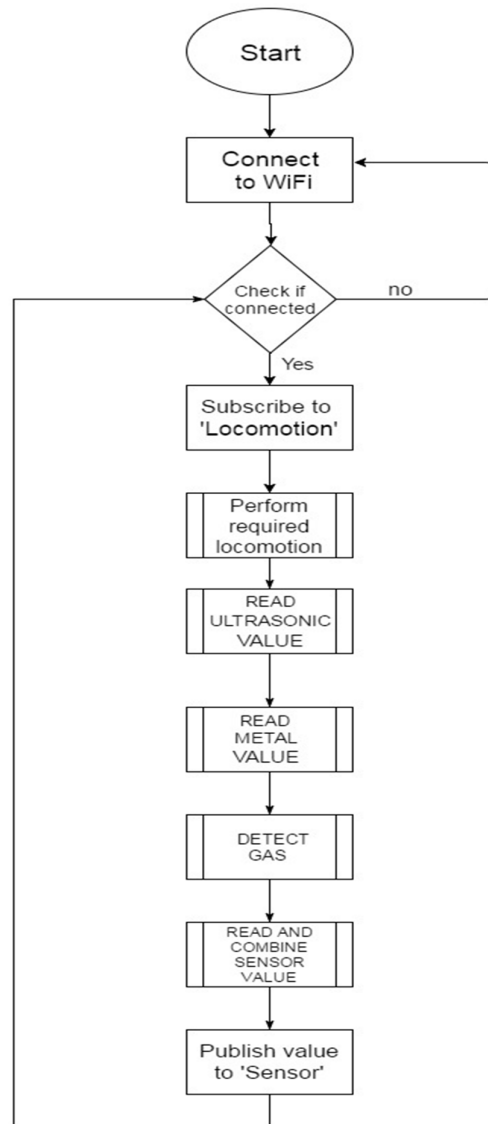

Figure 6. Algorithm to configure rover

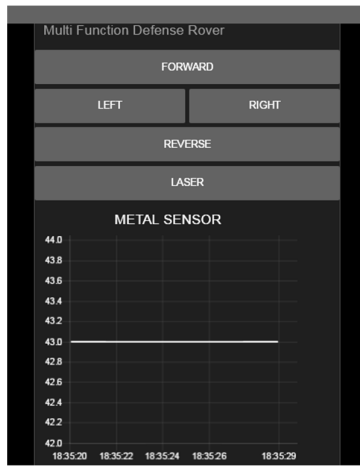

Figure 7. User Interface

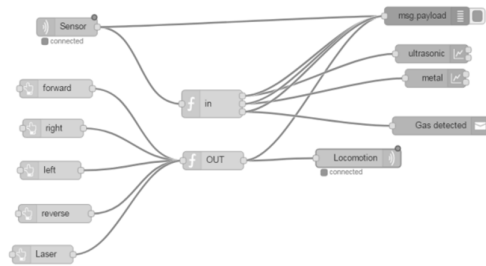

Figure 8. Broker Program

## VI. PLATFORMS USED

### A. Energia :

Energia, an open source and community-driven integrated development environment (IDE) and software framework, in combination with CC3200 SDK is used here. Based on the Wiring framework, Energia provides an exceptional coding environment along with a robust framework of easy-to-use functional APIs & libraries for programming a microcontroller.

### B. NodeRed:

NodeRed is used for wiring together hardware devices, API, and online Services. It comes in form of an online editor with a drag and drop tool. The basic framework for the broker done using NodeRed is shown in fig6.

### C. IBM Bluemix:

IBM Bluemix is a cloud platform developed and owned by IBM. It supports several programming languages and services. It is integrated with DevOps to build, run, deploy and manage applications on cloud

## VII. Result

A fully functional cloud controlled defense rover was built and was tested for working. Sensor readings were sampled two times per second. These values were immediately published to the cloud and the user was able to observe a plot of sensor readings v/s time graph on his/her device. It can also be observed that this rover has a virtually infinite range provided network access is available. This is shown in Figure 9. Also the user was able to control the locomotion of the rover using the user interface. A picture of the defense rover is shown in figure 10.

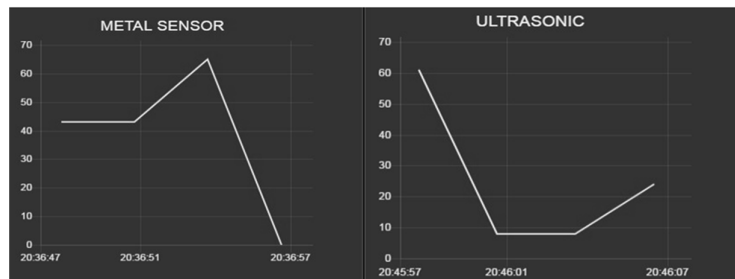

Figure 9: Sensor Reading being plotted versus time

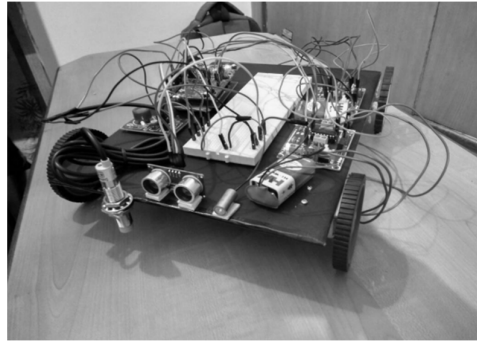

Figure 10: Defense Rover

### VIII. CONCLUSION

A fully functional, cloud controlled defence rover is presented here. Most of the sensors used here are prototype sensors and can be replaced by regular industry level sensors. The system proposed here was based on TI CC3200 in combination with IBM Bluemix cloud server.

We hope that in the future such a system can be built. As future developments a robotic arm can also be added onto the system to pick and dispose the bombs safely. The locomotion can further be improved by mounting the system on a quad copter or other forms of movement.

On the broker side more automation can be implemented to make the machine learn from its counter parts. More than one system can be connected to the same system and these can exchange data.

Other than defence rovers as described here, these rovers can be implemented in other areas such as mines, earthquake affected areas by slight modifications. We hope this system is constructively developed and is used for other embedded applications

### ACKNOWLEDGEMENTS

Authors are thankful to the Department of Electronics and Communication, JSS Academy of Technical Education for their continuous support and encouragement in this endeavour.

### REFERENCES

- [1] Prof. Vaibhav joshi, Sonali Katore, Yogini Bhandare, and Amol Kanade, "Wireless Bomb Defusing Robot with camera interfacing" , IJSRET, ISSN 2278 – 0882 ,Volume 5, Issue 4, April 2016.
- [2] Arun.R, Anandu Surendran, Atul Ravi, and Ragimol.M.G, "Design of Nano Robotics for Defense", IJIRSET ISSN 2347-6710 Vol. 5, Issue 4, April 2016.
- [3] Cloud Services, " <https://en.wikipedia.org>"
- [4] NodeRed, " <https://nodered.org>"
- [5] MQTT protocol, " <http://internetofthingsagenda.techtarget.com>"